

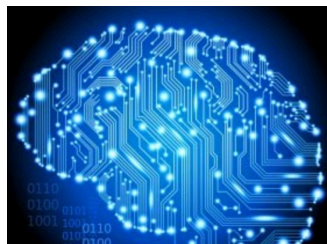

Lecture 7: Knowledge 2

http://cs.nju.edu.cn/yuy/course_ai18.ashx



Previously...



function HYBRID-WUMPUS-AGENT(*percept*) **returns** an *action*
inputs: *percept*, a list, [*stench*,*breeze*,*glitter*,*bump*,*scream*]
persistent: *KB*, a knowledge base, initially the atemporal “wumpus physics”
t, a counter, initially 0, indicating time
plan, an action sequence, initially empty

```
TELL(KB, MAKE-PERCEPT-SENTENCE(percept, t))
TELL the KB the temporal “physics” sentences for time t
safe ← {[x, y] : ASK(KB,  $OK_{x,y}^t = true$ )}
if ASK(KB,  $Glitter^t = true$ ) then
    plan ← [Grab] + PLAN-ROUTE(current, {[1,1]}, safe) + [Climb]
if plan is empty then
    unvisited ← {[x, y] : ASK(KB,  $L_{x,y}^{t'} = false$  for all  $t' \leq t$ )}
    plan ← PLAN-ROUTE(current, unvisited ∩ safe, safe)
if plan is empty and ASK(KB,  $HaveArrow^t = true$ ) then
    possible_wumpus ← {[x, y] : ASK(KB,  $\neg W_{x,y} = false$ )}
    plan ← PLAN-SHOT(current, possible_wumpus, safe)
if plan is empty then // no choice but to take a risk
    not_unsafe ← {[x, y] : ASK(KB,  $\neg OK_{x,y}^t = false$ )}
    plan ← PLAN-ROUTE(current, unvisited ∩ not_unsafe, safe)
if plan is empty then
    plan ← PLAN-ROUTE(current, {[1,1]}, safe) + [Climb]
action ← POP(plan)
TELL(KB, MAKE-ACTION-SENTENCE(action, t))
t ← t + 1
return action
```

function PLAN-ROUTE(*current*,*goals*,*allowed*) **returns** an action sequence

inputs: *current*, the agent’s current position
goals, a set of squares; try to plan a route to one of them
allowed, a set of squares that can form part of the route

```
problem ← ROUTE-PROBLEM(current, goals, allowed)
return A*-GRAPH-SEARCH(problem)
```

Pros and cons of propositional logic



- 😊 Propositional logic is **declarative**: pieces of syntax correspond to facts
- 😊 Propositional logic allows partial/disjunctive/negated information (unlike most data structures and databases)
- 😊 Propositional logic is **compositional**:
meaning of $B_{1,1} \wedge P_{1,2}$ is derived from meaning of $B_{1,1}$ and of $P_{1,2}$
- 😊 Meaning in propositional logic is **context-independent** (unlike natural language, where meaning depends on context)
- 😞 Propositional logic has very limited expressive power (unlike natural language)
E.g., cannot say “pits cause breezes in adjacent squares”
except by writing one sentence for each square

First-order logic



Whereas propositional logic assumes world contains **facts**,
first-order logic (like natural language) assumes the world contains

- **Objects**: people, houses, numbers, theories, Ronald McDonald, colors, baseball games, wars, centuries . . .
- **Relations**: red, round, bogus, prime, multistoried . . ., brother of, bigger than, inside, part of, has color, occurred after, owns, comes between, . . .
- **Functions**: father of, best friend, third inning of, one more than, end of . . .

Logics in general



Language	Ontological Commitment	Epistemological Commitment
Propositional logic	facts	true/false/unknown
First-order logic	facts, objects, relations	true/false/unknown
Temporal logic	facts, objects, relations, times	true/false/unknown
Probability theory	facts	degree of belief
Fuzzy logic	facts + degree of truth	known interval value

Syntax of FOL: Basic elements



Constants	<i>KingJohn, 2, UCB, ...</i>
Predicates	<i>Brother, >, ...</i>
Functions	<i>Sqrt, LeftLegOf, ...</i>
Variables	<i>x, y, a, b, ...</i>
Connectives	$\wedge \vee \neg \Rightarrow \Leftrightarrow$
Equality	$=$
Quantifiers	$\forall \exists$

Atomic sentences



Atomic sentence = *predicate*(*term*₁, ..., *term*_{*n*})
or *term*₁ = *term*₂

Term = *function*(*term*₁, ..., *term*_{*n*})
or *constant* or *variable*

E.g., *Brother*(*KingJohn*, *RichardTheLionheart*)
> (*Length*(*LeftLegOf*(*Richard*)), *Length*(*LeftLegOf*(*KingJohn*)))

Complex sentences



Complex sentences are made from atomic sentences using connectives

$$\neg S, \quad S_1 \wedge S_2, \quad S_1 \vee S_2, \quad S_1 \Rightarrow S_2, \quad S_1 \Leftrightarrow S_2$$

E.g. $Sibling(KingJohn, Richard) \Rightarrow Sibling(Richard, KingJohn)$

$$>(1, 2) \vee \leq(1, 2)$$

$$>(1, 2) \wedge \neg >(1, 2)$$

Truth in first-order logic



Sentences are true with respect to a **model** and an **interpretation**

Model contains ≥ 1 objects (**domain elements**) and relations among them

Interpretation specifies referents for

constant symbols \rightarrow **objects**

predicate symbols \rightarrow **relations**

function symbols \rightarrow **functional relations**

An atomic sentence $\textit{predicate}(\textit{term}_1, \dots, \textit{term}_n)$ is true
iff the **objects** referred to by $\textit{term}_1, \dots, \textit{term}_n$
are in the **relation** referred to by $\textit{predicate}$

Models for FOL: Example

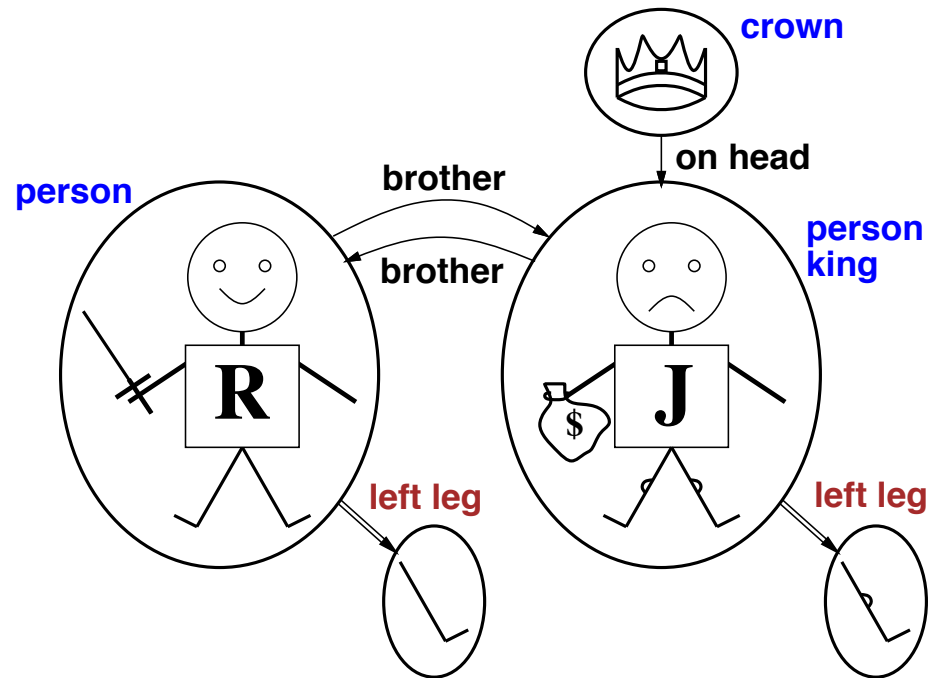

Consider the interpretation in which

Richard → Richard the Lionheart

John → the evil King John

Brother → the brotherhood relation

Under this interpretation, $Brother(Richard, John)$ is true just in case Richard the Lionheart and the evil King John are in the brotherhood relation in the model

Models for FOL: Lots!



Entailment in propositional logic can be computed by enumerating models

We **can** enumerate the FOL models for a given KB vocabulary:

For each number of domain elements n from 1 to ∞

 For each k -ary predicate P_k in the vocabulary

 For each possible k -ary relation on n objects

 For each constant symbol C in the vocabulary

 For each choice of referent for C from n objects ...

Computing entailment by enumerating FOL models is not easy!

Universal quantification



$\forall \langle \text{variables} \rangle \langle \text{sentence} \rangle$

Everyone at Berkeley is smart:

$\forall x \text{ At}(x, \text{Berkeley}) \Rightarrow \text{Smart}(x)$

$\forall x P$ is true in a model m iff P is true with x being **each** possible object in the model

Roughly speaking, equivalent to the conjunction of instantiations of P

$(\text{At}(\text{KingJohn}, \text{Berkeley}) \Rightarrow \text{Smart}(\text{KingJohn}))$
 $\wedge (\text{At}(\text{Richard}, \text{Berkeley}) \Rightarrow \text{Smart}(\text{Richard}))$
 $\wedge (\text{At}(\text{Berkeley}, \text{Berkeley}) \Rightarrow \text{Smart}(\text{Berkeley}))$
 $\wedge \dots$

A common mistake to avoid



Typically, \Rightarrow is the main connective with \forall

Common mistake: using \wedge as the main connective with \forall :

$$\forall x \text{ } At(x, Berkeley) \wedge Smart(x)$$

means “Everyone is at Berkeley and everyone is smart”

Existential quantification



$\exists \langle \text{variables} \rangle \langle \text{sentence} \rangle$

Someone at Stanford is smart:

$\exists x \text{ At}(x, \text{Stanford}) \wedge \text{Smart}(x)$

$\exists x P$ is true in a model m iff P is true with x being **some** possible object in the model

Roughly speaking, equivalent to the disjunction of instantiations of P

$(\text{At}(\text{KingJohn}, \text{Stanford}) \wedge \text{Smart}(\text{KingJohn}))$
 $\vee (\text{At}(\text{Richard}, \text{Stanford}) \wedge \text{Smart}(\text{Richard}))$
 $\vee (\text{At}(\text{Stanford}, \text{Stanford}) \wedge \text{Smart}(\text{Stanford}))$
 $\vee \dots$

Another common mistake to avoid



Typically, \wedge is the main connective with \exists

Common mistake: using \Rightarrow as the main connective with \exists :

$$\exists x \text{ At}(x, \text{Stanford}) \Rightarrow \text{Smart}(x)$$

is true if there is anyone who is not at Stanford!

Properties of quantifiers



$\forall x \forall y$ is the same as $\forall y \forall x$ (why??)

$\exists x \exists y$ is the same as $\exists y \exists x$ (why??)

$\exists x \forall y$ is **not** the same as $\forall y \exists x$

$\exists x \forall y \text{ Loves}(x, y)$

“There is a person who loves everyone in the world”

$\forall y \exists x \text{ Loves}(x, y)$

“Everyone in the world is loved by at least one person”

Quantifier duality: each can be expressed using the other

$\forall x \text{ Likes}(x, \text{IceCream}) \quad \neg \exists x \neg \text{Likes}(x, \text{IceCream})$

$\exists x \text{ Likes}(x, \text{Broccoli}) \quad \neg \forall x \neg \text{Likes}(x, \text{Broccoli})$

Fun with sentences



Brothers are siblings

$$\forall x, y \text{ Brother}(x, y) \Rightarrow \text{Sibling}(x, y).$$

“Sibling” is symmetric

$$\forall x, y \text{ Sibling}(x, y) \Leftrightarrow \text{Sibling}(y, x).$$

One’s mother is one’s female parent

$$\forall x, y \text{ Mother}(x, y) \Leftrightarrow (\text{Female}(x) \wedge \text{Parent}(x, y)).$$

A first cousin is a child of a parent’s sibling

$$\forall x, y \text{ FirstCousin}(x, y) \Leftrightarrow \exists p, ps \text{ Parent}(p, x) \wedge \text{Sibling}(ps, p) \wedge \text{Parent}(ps, y)$$

Equality



$term_1 = term_2$ is true under a given interpretation
if and only if $term_1$ and $term_2$ refer to the same object

E.g., $1 = 2$ and $\forall x \times(Sqrt(x), Sqrt(x)) = x$ are satisfiable
 $2 = 2$ is valid

E.g., definition of (full) *Sibling* in terms of *Parent*:

$$\forall x, y \text{ Sibling}(x, y) \Leftrightarrow [\neg(x = y) \wedge \exists m, f \neg(m = f) \wedge \\ \text{Parent}(m, x) \wedge \text{Parent}(f, x) \wedge \text{Parent}(m, y) \wedge \text{Parent}(f, y)]$$



Interacting with FOL KBs

Suppose a wumpus-world agent is using an FOL KB and perceives a smell and a breeze (but no glitter) at $t = 5$:

$Tell(KB, Percept([Smell, Breeze, None], 5))$

$Ask(KB, \exists a \text{ Action}(a, 5))$

I.e., does KB entail any particular actions at $t = 5$?

Answer: $Yes, \{a/Shoot\}$ ← substitution (binding list)

Given a sentence S and a substitution σ ,

$S\sigma$ denotes the result of plugging σ into S ; e.g.,

$S = Smarter(x, y)$

$\sigma = \{x/Hillary, y/Bill\}$

$S\sigma = Smarter(Hillary, Bill)$

$Ask(KB, S)$ returns some/all σ such that $KB \models S\sigma$

Knowledge base for the wumpus world



“Perception”

$\forall b, g, t \text{ Percept}([Smell, b, g], t) \Rightarrow Smelt(t)$

$\forall s, b, t \text{ Percept}([s, b, Glitter], t) \Rightarrow AtGold(t)$

Reflex: $\forall t \text{ AtGold}(t) \Rightarrow \text{Action}(Grab, t)$

Reflex with internal state: do we have the gold already?

$\forall t \text{ AtGold}(t) \wedge \neg Holding(Gold, t) \Rightarrow \text{Action}(Grab, t)$

$Holding(Gold, t)$ cannot be observed

\Rightarrow keeping track of change is essential

Deducing hidden properties



Properties of locations:

$$\forall x, t \text{ At}(\text{Agent}, x, t) \wedge \text{Smelt}(t) \Rightarrow \text{Smelly}(x)$$

$$\forall x, t \text{ At}(\text{Agent}, x, t) \wedge \text{Breeze}(t) \Rightarrow \text{Breezy}(x)$$

Squares are breezy near a pit:

Diagnostic rule—infer cause from effect

$$\forall y \text{ Breezy}(y) \Rightarrow \exists x \text{ Pit}(x) \wedge \text{Adjacent}(x, y)$$

Causal rule—infer effect from cause

$$\forall x, y \text{ Pit}(x) \wedge \text{Adjacent}(x, y) \Rightarrow \text{Breezy}(y)$$

Neither of these is complete—e.g., the causal rule doesn't say whether squares far away from pits can be breezy

Definition for the *Breezy* predicate:

$$\forall y \text{ Breezy}(y) \Leftrightarrow [\exists x \text{ Pit}(x) \wedge \text{Adjacent}(x, y)]$$



Keeping track of change

Facts hold in **situations**, rather than eternally

E.g., *Holding(Gold, Now)* rather than just *Holding(Gold)*

Situation calculus is one way to represent change in FOL:

Adds a situation argument to each non-eternal predicate

E.g., *Now* in *Holding(Gold, Now)* denotes a situation

Situations are connected by the *Result* function

Result(a, s) is the situation that results from doing *a* in *s*

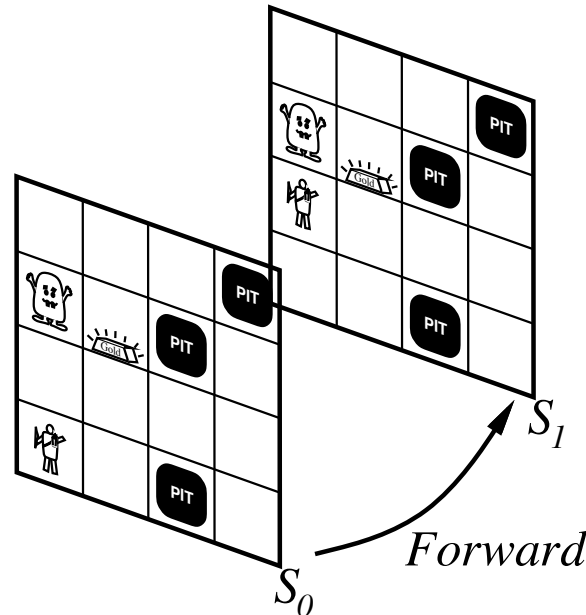

Describing actions I



“Effect” axiom—describe changes due to action

$$\forall s \text{ AtGold}(s) \Rightarrow \text{Holding}(\text{Gold}, \text{Result}(\text{Grab}, s))$$

“Frame” axiom—describe **non-changes** due to action

$$\forall s \text{ HaveArrow}(s) \Rightarrow \text{HaveArrow}(\text{Result}(\text{Grab}, s))$$

Frame problem: find an elegant way to handle non-change

- (a) representation—avoid frame axioms
- (b) inference—avoid repeated “copy-overs” to keep track of state

Qualification problem: true descriptions of real actions require endless caveats—what if gold is slippery or nailed down or ...

Ramification problem: real actions have many secondary consequences—what about the dust on the gold, wear and tear on gloves, ...

Describing actions II



Successor-state axioms solve the representational frame problem

Each axiom is “about” a **predicate** (not an action per se):

$$\begin{aligned} P \text{ true afterwards} &\Leftrightarrow [\text{an action made } P \text{ true} \\ &\vee P \text{ true already and no action made } P \text{ false}] \end{aligned}$$

For holding the gold:

$$\begin{aligned} \forall a, s \text{ Holding}(\text{Gold}, \text{Result}(a, s)) &\Leftrightarrow \\ &[(a = \text{Grab} \wedge \text{AtGold}(s)) \\ &\vee (\text{Holding}(\text{Gold}, s) \wedge a \neq \text{Release})] \end{aligned}$$

Making plans



Initial condition in KB:

$At(Agent, [1, 1], S_0)$

$At(Gold, [1, 2], S_0)$

Query: $Ask(KB, \exists s \text{ Holding}(Gold, s))$

i.e., in what situation will I be holding the gold?

Answer: $\{s / Result(Grab, Result(Forward, S_0))\}$

i.e., go forward and then grab the gold

This assumes that the agent is interested in plans starting at S_0 and that S_0 is the only situation described in the KB

Making plans: A better way



Represent **plans** as action sequences $[a_1, a_2, \dots, a_n]$

$PlanResult(p, s)$ is the result of executing p in s

Then the query $Ask(KB, \exists p \text{ Holding}(Gold, PlanResult(p, S_0)))$
has the solution $\{p/[Forward, Grab]\}$

Definition of $PlanResult$ in terms of $Result$:

$$\forall s \text{ PlanResult}([], s) = s$$

$$\forall a, p, s \text{ PlanResult}([a|p], s) = \text{PlanResult}(p, \text{Result}(a, s))$$

Planning systems are special-purpose reasoners designed to do this type of inference more efficiently than a general-purpose reasoner

Summary



First-order logic:

- objects and relations are semantic primitives
- syntax: constants, functions, predicates, equality, quantifiers

Increased expressive power: sufficient to define wumpus world

Situation calculus:

- conventions for describing actions and change in FOL
- can formulate planning as inference on a situation calculus KB

A brief history of reasoning



450B.C.	Stoics	propositional logic, inference (maybe)
322B.C.	Aristotle	“syllogisms” (inference rules), quantifiers
1565	Cardano	probability theory (propositional logic + uncertainty)
1847	Boole	propositional logic (again)
1879	Frege	first-order logic
1922	Wittgenstein	proof by truth tables
1930	Gödel	\exists complete algorithm for FOL
1930	Herbrand	complete algorithm for FOL (reduce to propositional)
1931	Gödel	$\neg\exists$ complete algorithm for arithmetic
1960	Davis/Putnam	“practical” algorithm for propositional logic
1965	Robinson	“practical” algorithm for FOL—resolution

Universal instantiation (UI)



Every instantiation of a universally quantified sentence is entailed by it:

$$\frac{\forall v \alpha}{\text{SUBST}(\{v/g\}, \alpha)}$$

for any variable v and ground term g

E.g., $\forall x \text{ King}(x) \wedge \text{Greedy}(x) \Rightarrow \text{Evil}(x)$ yields

$$\text{King}(\text{John}) \wedge \text{Greedy}(\text{John}) \Rightarrow \text{Evil}(\text{John})$$

$$\text{King}(\text{Richard}) \wedge \text{Greedy}(\text{Richard}) \Rightarrow \text{Evil}(\text{Richard})$$

$$\text{King}(\text{Father}(\text{John})) \wedge \text{Greedy}(\text{Father}(\text{John})) \Rightarrow \text{Evil}(\text{Father}(\text{John}))$$



Existential instantiation (EI)

For any sentence α , variable v , and constant symbol k that does not appear elsewhere in the knowledge base:

$$\frac{\exists v \alpha}{\text{SUBST}(\{v/k\}, \alpha)}$$

E.g., $\exists x \text{Crown}(x) \wedge \text{OnHead}(x, \text{John})$ yields

$$\text{Crown}(C_1) \wedge \text{OnHead}(C_1, \text{John})$$

provided C_1 is a new constant symbol, called a Skolem constant

Another example: from $\exists x \text{d}(x^y)/\text{d}y = x^y$ we obtain

$$\text{d}(e^y)/\text{d}y = e^y$$

provided e is a new constant symbol

Instantiation



UI can be applied several times to **add** new sentences;
the new KB is logically equivalent to the old

EI can be applied once to **replace** the existential sentence;
the new KB is **not** equivalent to the old,
but is satisfiable iff the old KB was satisfiable

Reduction to propositional inference



Suppose the KB contains just the following:

$$\forall x \text{ King}(x) \wedge \text{Greedy}(x) \Rightarrow \text{Evil}(x)$$

King(John)

Greedy(John)

Brother(Richard, John)

Instantiating the universal sentence in **all possible** ways, we have

$$\text{King}(\text{John}) \wedge \text{Greedy}(\text{John}) \Rightarrow \text{Evil}(\text{John})$$

$$\text{King}(\text{Richard}) \wedge \text{Greedy}(\text{Richard}) \Rightarrow \text{Evil}(\text{Richard})$$

King(John)

Greedy(John)

Brother(Richard, John)

The new KB is **propositionalized**: proposition symbols are

King(John), Greedy(John), Evil(John), King(Richard) etc.

Reduction to propositional inference



Claim: a ground sentence* is entailed by new KB iff entailed by original KB

Claim: every FOL KB can be propositionalized so as to preserve entailment

Idea: propositionalize KB and query, apply resolution, return result

Problem: with function symbols, there are infinitely many ground terms,
e.g., *Father(Father(Father(John)))*

Theorem: Herbrand (1930). If a sentence α is entailed by an FOL KB,
it is entailed by a **finite** subset of the propositional KB

Idea: For $n = 0$ to ∞ do
 create a propositional KB by instantiating with depth- n terms
 see if α is entailed by this KB

Problem: works if α is entailed, loops if α is not entailed

Theorem: Turing (1936), Church (1936), entailment in FOL is **semidecidable**

Problems with propositionalization



Propositionalization seems to generate lots of irrelevant sentences.

E.g., from

$$\forall x \text{ King}(x) \wedge \text{Greedy}(x) \Rightarrow \text{Evil}(x)$$

$\text{King}(\text{John})$

$\forall y \text{ Greedy}(y)$

$\text{Brother}(\text{Richard}, \text{John})$

it seems obvious that $\text{Evil}(\text{John})$, but propositionalization produces lots of facts such as $\text{Greedy}(\text{Richard})$ that are irrelevant

With p k -ary predicates and n constants, there are $p \cdot n^k$ instantiations

With function symbols, it gets much much worse!

Unification



We can get the inference immediately if we can find a substitution θ such that $King(x)$ and $Greedy(x)$ match $King(John)$ and $Greedy(y)$

$\theta = \{x/John, y/John\}$ works

$UNIFY(\alpha, \beta) = \theta$ if $\alpha\theta = \beta\theta$

p	q	θ
$Knows(John, x)$	$Knows(John, Jane)$	$\{x/Jane\}$
$Knows(John, x)$	$Knows(y, OJ)$	$\{x/OJ, y/John\}$
$Knows(John, x)$	$Knows(y, Mother(y))$	$\{y/John, x/Mother(John)\}$
$Knows(John, x)$	$Knows(x, OJ)$	<i>fail</i>

Standardizing apart eliminates overlap of variables, e.g., $Knows(z_{17}, OJ)$

Generalized Modus Ponens (GMP)

(前件推理)



$$\frac{p_1', p_2', \dots, p_n', (p_1 \wedge p_2 \wedge \dots \wedge p_n \Rightarrow q)}{q\theta}$$

where $p_i'\theta = p_i\theta$ for all i

p_1' is *King(John)*

p_1 is *King(x)*

p_2' is *Greedy(y)*

p_2 is *Greedy(x)*

θ is $\{x/\text{John}, y/\text{John}\}$ q is *Evil(x)*

$q\theta$ is *Evil(John)*

GMP used with KB of **definite clauses** (**exactly** one positive literal)

All variables assumed universally quantified

Soundness of GMP



Need to show that

$$p_1', \dots, p_n', (p_1 \wedge \dots \wedge p_n \Rightarrow q) \models q\theta$$

provided that $p_i'\theta = p_i\theta$ for all i

Lemma: For any definite clause p , we have $p \models p\theta$ by UI

1. $(p_1 \wedge \dots \wedge p_n \Rightarrow q) \models (p_1 \wedge \dots \wedge p_n \Rightarrow q)\theta = (p_1\theta \wedge \dots \wedge p_n\theta \Rightarrow q\theta)$
2. $p_1', \dots, p_n' \models p_1' \wedge \dots \wedge p_n' \models p_1'\theta \wedge \dots \wedge p_n'\theta$
3. From 1 and 2, $q\theta$ follows by ordinary Modus Ponens

Example knowledge base



The law says that it is a crime for an American to sell weapons to hostile nations. The country Nono, an enemy of America, has some missiles, and all of its missiles were sold to it by Colonel West, who is American.

Prove that Col. West is a criminal

... it is a crime for an American to sell weapons to hostile nations:

$$\textit{American}(x) \wedge \textit{Weapon}(y) \wedge \textit{Sells}(x, y, z) \wedge \textit{Hostile}(z) \Rightarrow \textit{Criminal}(x)$$

Nono ... has some missiles, i.e., $\exists x \textit{Owns}(\textit{Nono}, x) \wedge \textit{Missile}(x)$:

$$\textit{Owns}(\textit{Nono}, M_1) \text{ and } \textit{Missile}(M_1)$$

... all of its missiles were sold to it by Colonel West

$$\forall x \textit{Missile}(x) \wedge \textit{Owns}(\textit{Nono}, x) \Rightarrow \textit{Sells}(\textit{West}, x, \textit{Nono})$$

Missiles are weapons:

$$\textit{Missile}(x) \Rightarrow \textit{Weapon}(x)$$

An enemy of America counts as "hostile":

$$\textit{Enemy}(x, \textit{America}) \Rightarrow \textit{Hostile}(x)$$

West, who is American ...

$$\textit{American}(\textit{West})$$

The country Nono, an enemy of America ...

$$\textit{Enemy}(\textit{Nono}, \textit{America})$$

Forward chaining algorithm



function FOL-FC-Ask(KB, α) **returns** a substitution or *false*

repeat until new is empty

$new \leftarrow \{ \}$

for each sentence r **in** KB **do**

$(p_1 \wedge \dots \wedge p_n \Rightarrow q) \leftarrow \text{STANDARDIZE-APART}(r)$

for each θ such that $(p_1 \wedge \dots \wedge p_n)\theta = (p'_1 \wedge \dots \wedge p'_n)\theta$

for some p'_1, \dots, p'_n in KB

$q' \leftarrow \text{SUBST}(\theta, q)$

if q' is not a renaming of a sentence already in KB or new **then do**

add q' to new

$\phi \leftarrow \text{UNIFY}(q', \alpha)$

if ϕ is not *fail* **then return** ϕ

add new to KB

return *false*

Forward chaining proof

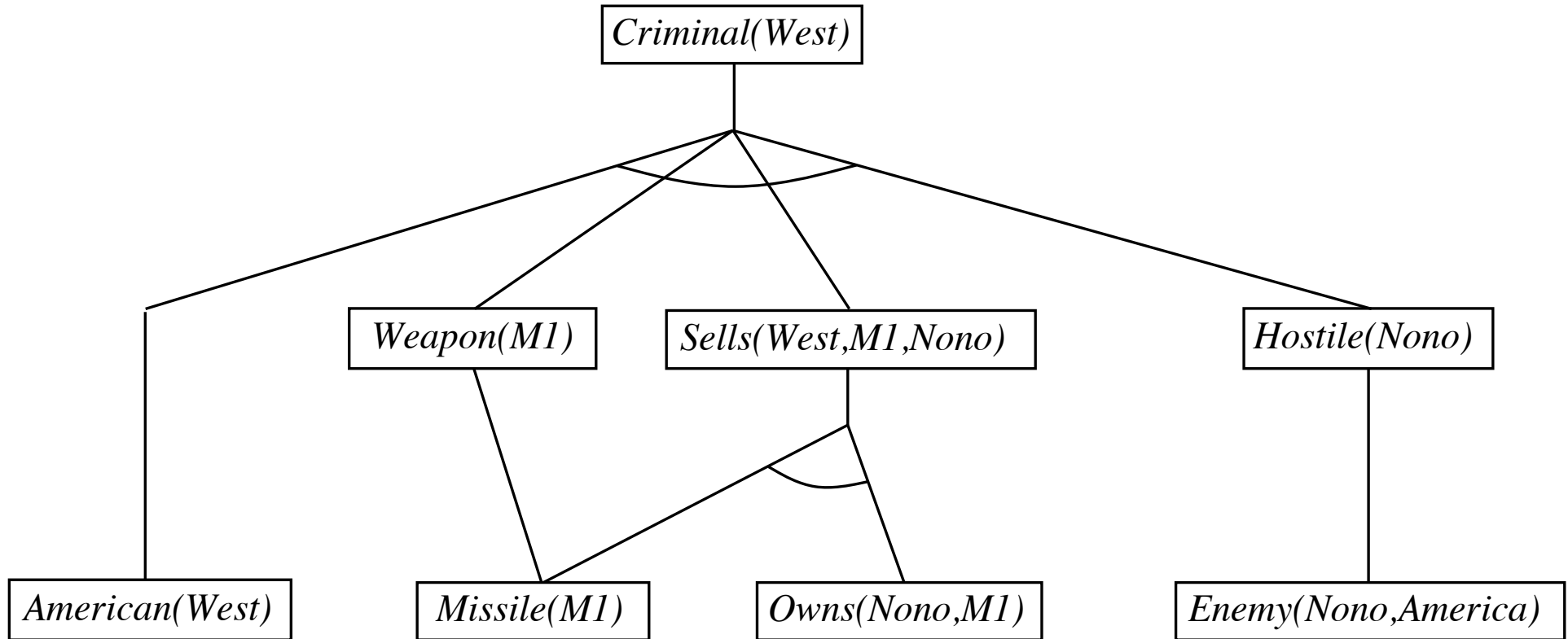

Properties of forward chaining



Sound and complete for first-order definite clauses
(proof similar to propositional proof)

Datalog = first-order definite clauses + **no functions** (e.g., crime KB)
FC terminates for Datalog in poly iterations: at most $p \cdot n^k$ literals

May not terminate in general if α is not entailed

This is unavoidable: entailment with definite clauses is semidecidable

Efficiency of forward chaining



Simple observation: no need to match a rule on iteration k
if a premise wasn't added on iteration $k - 1$

\Rightarrow match each rule whose premise contains a newly added literal

Matching itself can be expensive

Database indexing allows $O(1)$ retrieval of known facts

e.g., query $Missile(x)$ retrieves $Missile(M_1)$

Matching conjunctive premises against known facts is NP-hard

Forward chaining is widely used in deductive databases

Hard matching example

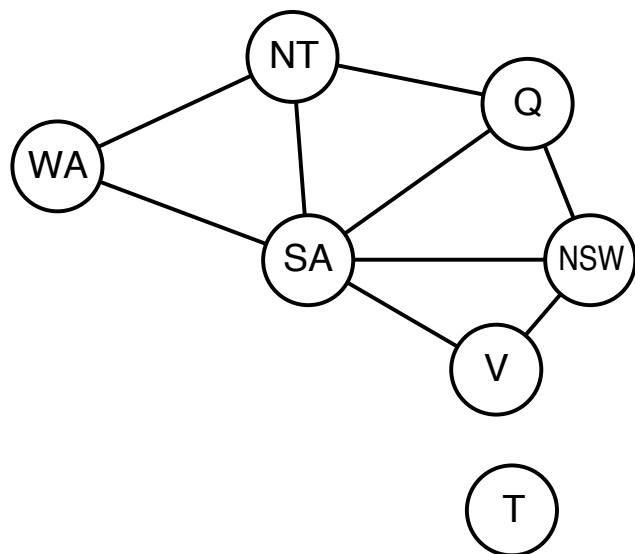

$$\begin{aligned} & Diff(wa, nt) \wedge Diff(wa, sa) \wedge \\ & Diff(nt, q) Diff(nt, sa) \wedge \\ & Diff(q, nsw) \wedge Diff(q, sa) \wedge \\ & Diff(nsw, v) \wedge Diff(nsw, sa) \wedge \\ & Diff(v, sa) \Rightarrow Colorable() \end{aligned}$$

$$\begin{aligned} & Diff(Red, Blue) \quad Diff(Red, Green) \\ & Diff(Green, Red) \quad Diff(Green, Blue) \\ & Diff(Blue, Red) \quad Diff(Blue, Green) \end{aligned}$$

Colorable() is inferred iff the CSP has a solution

CSPs include 3SAT as a special case, hence matching is NP-hard

Backward chaining algorithm



function FOL-BC-ASK($KB, goals, \theta$) **returns** a set of substitutions

inputs: KB , a knowledge base

$goals$, a list of conjuncts forming a query (θ already applied)

θ , the current substitution, initially the empty substitution $\{ \}$

local variables: $answers$, a set of substitutions, initially empty

if $goals$ is empty **then return** $\{ \theta \}$

$q' \leftarrow \text{SUBST}(\theta, \text{FIRST}(goals))$

for each sentence r **in** KB

where $\text{STANDARDIZE-APART}(r) = (p_1 \wedge \dots \wedge p_n \Rightarrow q)$

and $\theta' \leftarrow \text{UNIFY}(q, q')$ succeeds

$new_goals \leftarrow [p_1, \dots, p_n | \text{REST}(goals)]$

$answers \leftarrow \text{FOL-BC-ASK}(KB, new_goals, \text{COMPOSE}(\theta', \theta)) \cup answers$

return $answers$

Backward chaining example

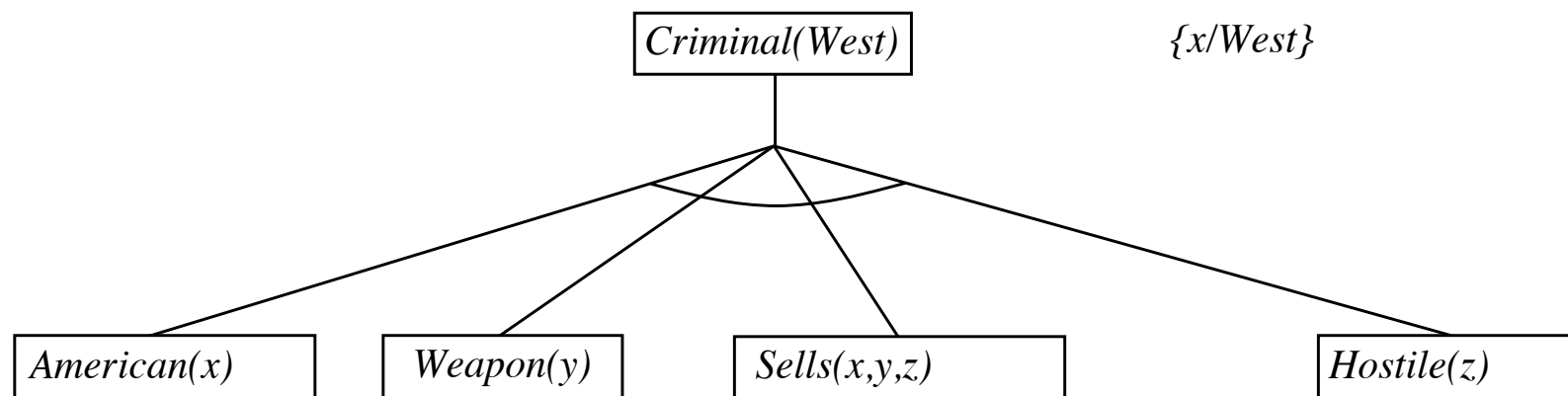

Backward chaining example

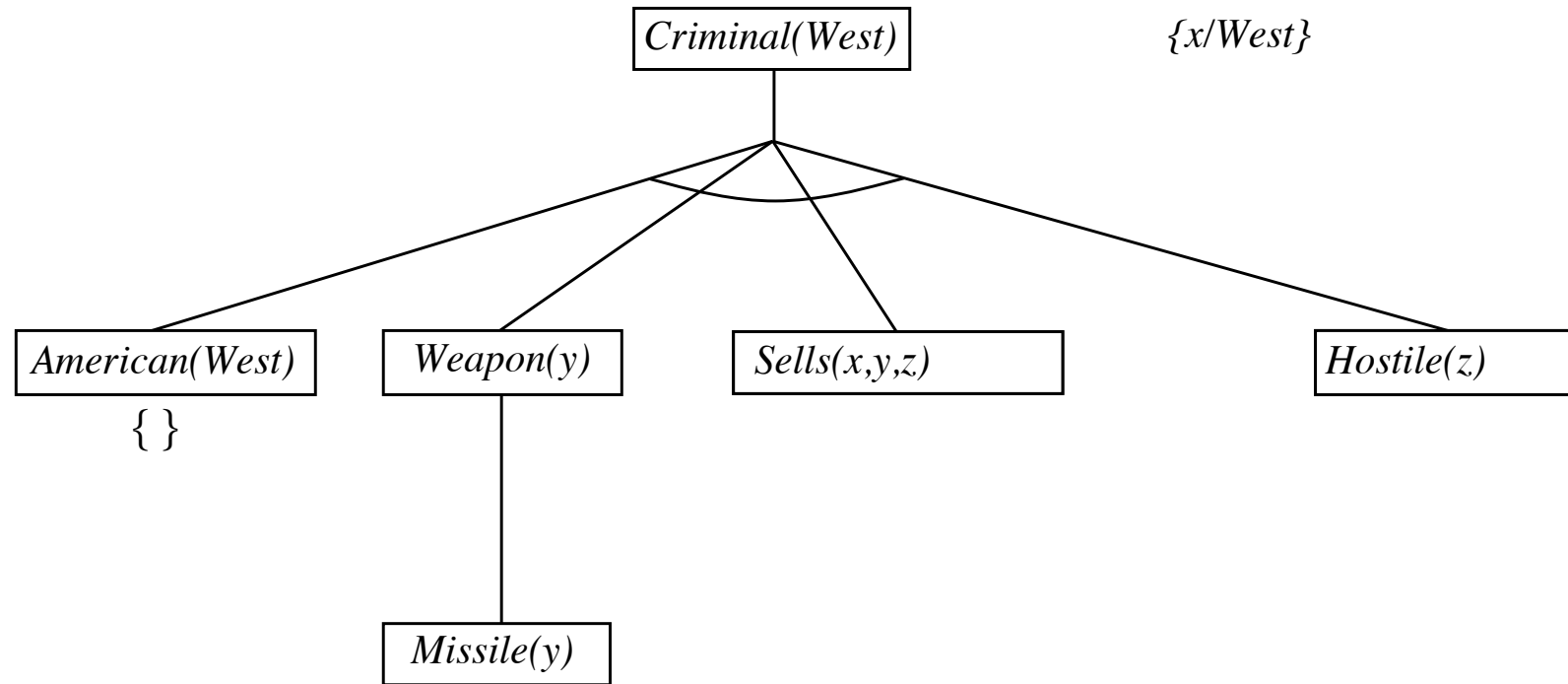

Backward chaining example

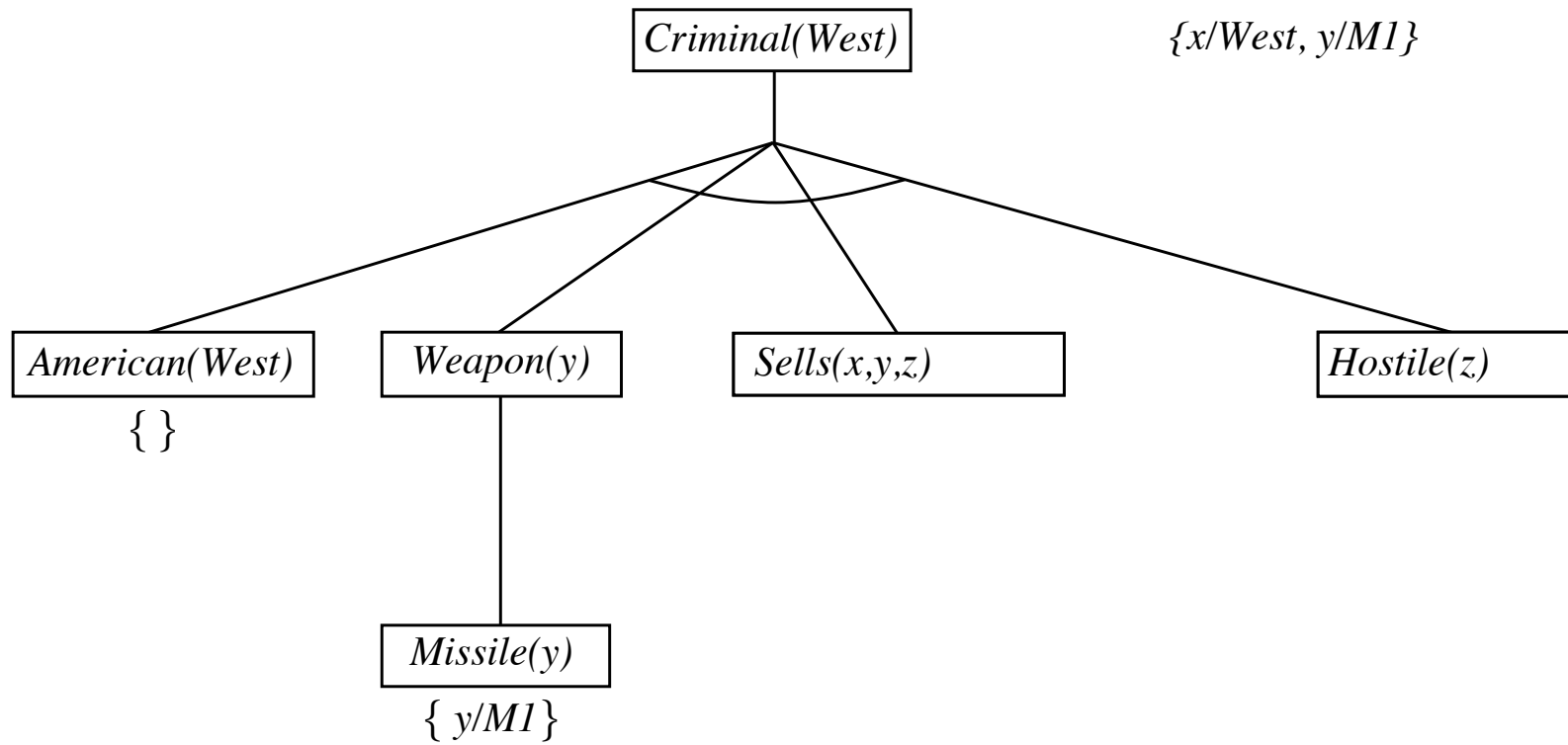

Backward chaining example

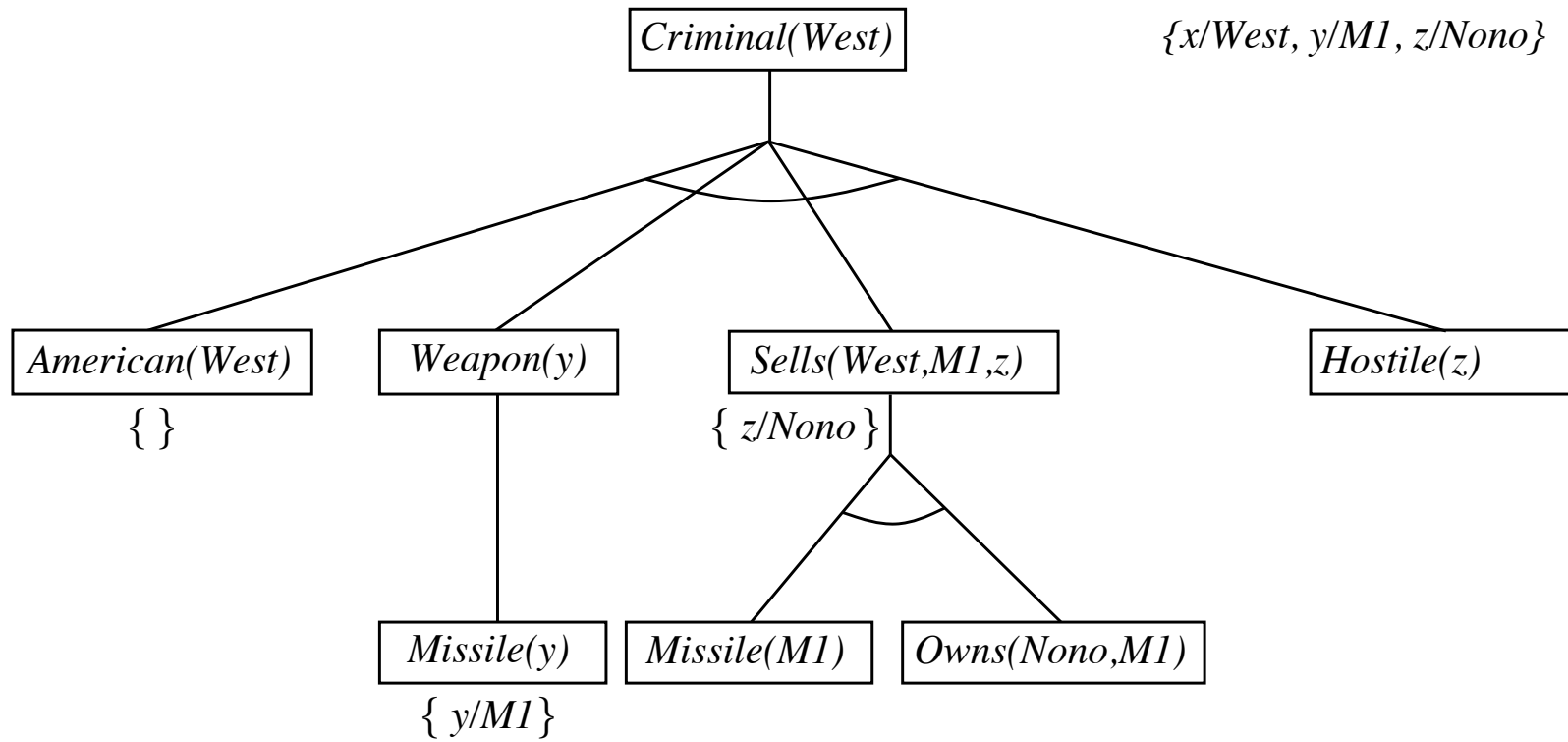

Backward chaining example

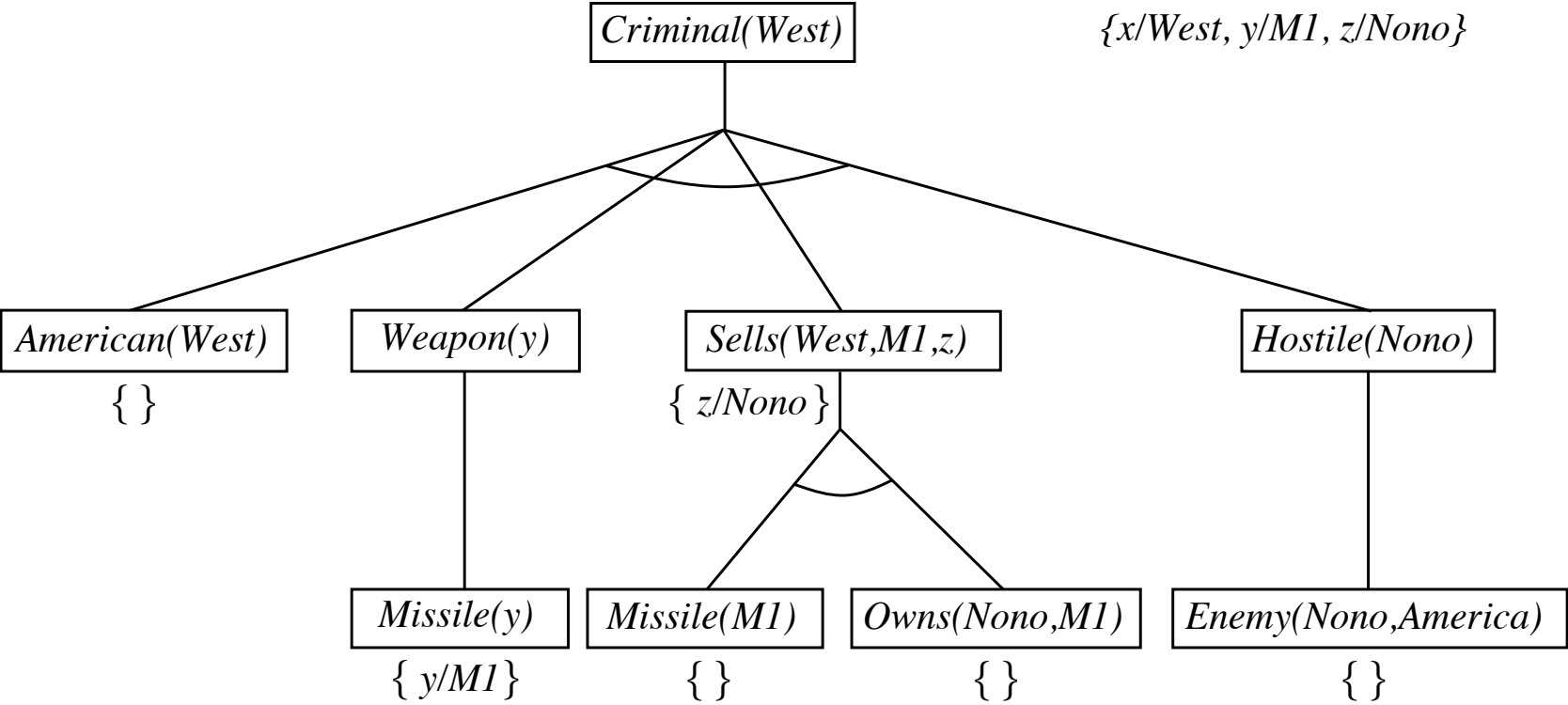

Properties of backward chaining



Depth-first recursive proof search: space is linear in size of proof

Incomplete due to infinite loops

⇒ fix by checking current goal against every goal on stack

Inefficient due to repeated subgoals (both success and failure)

⇒ fix using caching of previous results (extra space!)

Widely used (without improvements!) for **logic programming**

Logic programming



Sound bite: computation as inference on logical KBs

Logic programming

1. Identify problem
2. Assemble information
3. Tea break
4. Encode information in KB
5. Encode problem instance as facts
6. Ask queries
7. Find false facts

Ordinary programming

- Identify problem
- Assemble information
- Figure out solution
- Program solution
- Encode problem instance as data
- Apply program to data
- Debug procedural errors

Should be easier to debug *Capital(NewYork, US)* than $x := x + 2$!

Prolog systems



Basis: backward chaining with Horn clauses + bells & whistles
Widely used in Europe, Japan (basis of 5th Generation project)
Compilation techniques \Rightarrow approaching a billion LIPS

Program = set of clauses = head :- literal₁, ... literal_n.

`criminal(X) :- american(X), weapon(Y), sells(X,Y,Z), hostile(Z).`

Efficient unification by [open coding](#)

Efficient retrieval of matching clauses by direct linking

Depth-first, left-to-right backward chaining

Built-in predicates for arithmetic etc., e.g., `X is Y*Z+3`

Closed-world assumption (“negation as failure”)

e.g., given `alive(X) :- not dead(X).`

`alive(joe)` succeeds if `dead(joe)` fails

Prolog examples



Depth-first search from a start state X:

```
dfs(X) :- goal(X).
```

```
dfs(X) :- successor(X,S),dfs(S).
```

No need to loop over S: successor succeeds for each

Appending two lists to produce a third:

```
append([],Y,Y).
```

```
append([X|L],Y,[X|Z]) :- append(L,Y,Z).
```

```
query:    append(A,B,[1,2]) ?
```

```
answers:  A=[]      B=[1,2]
```

```
          A=[1]     B=[2]
```

```
          A=[1,2]   B=[]
```

Prolog example



Let's try

```
member(1,[1,2,3,4,5])
```

```
query: grandfather(X,yuqing)?
```

```
male(di).
```

```
male(jianbo).
```

```
female(xin).
```

```
female(yuan).
```

```
female(yuqing).
```

```
father(jianbo,di).
```

```
father(di,yuqing).
```

```
mother(xin,di).
```

```
mother(yuan,yuqing).
```

```
grandfather(X,Y):-father(X,Z),father(Z,Y).
```

```
grandmother(X,Y):-mother(X,Z),father(Z,Y).
```

```
daughter(X,Y):-father(X,Y),female(Y).
```

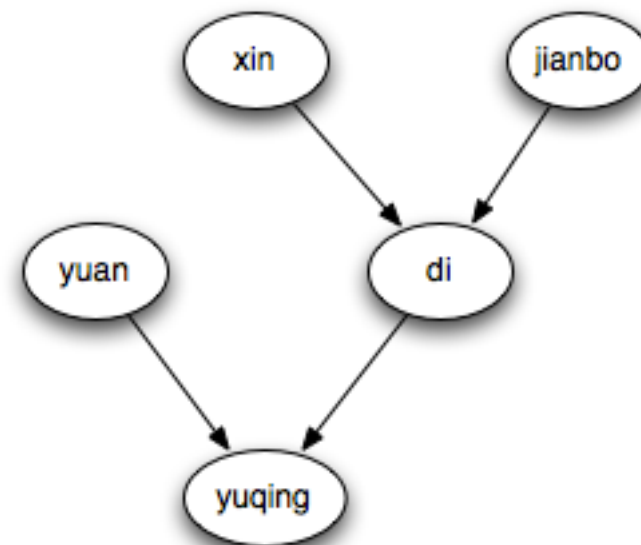

Prolog example



```
AI17 — -bash — bash — ttys000 — 59x23  
eyounxRMBP15:AI17 yuy$
```

Resolution: brief summary



Full first-order version:

$$\frac{\ell_1 \vee \cdots \vee \ell_k, \quad m_1 \vee \cdots \vee m_n}{(\ell_1 \vee \cdots \vee \ell_{i-1} \vee \ell_{i+1} \vee \cdots \vee \ell_k \vee m_1 \vee \cdots \vee m_{j-1} \vee m_{j+1} \vee \cdots \vee m_n)\theta}$$

where $\text{UNIFY}(\ell_i, \neg m_j) = \theta$.

For example,

$$\frac{\neg Rich(x) \vee Unhappy(x) \quad Rich(Ken)}{Unhappy(Ken)}$$

with $\theta = \{x/Ken\}$

Apply resolution steps to $CNF(KB \wedge \neg\alpha)$; complete for FOL

Conversion to CNF



Everyone who loves all animals is loved by someone:

$$\forall x [\forall y \text{ Animal}(y) \Rightarrow \text{Loves}(x, y)] \Rightarrow [\exists y \text{ Loves}(y, x)]$$

1. Eliminate biconditionals and implications

$$\forall x [\neg \forall y \neg \text{Animal}(y) \vee \text{Loves}(x, y)] \vee [\exists y \text{ Loves}(y, x)]$$

2. Move \neg inwards: $\neg \forall x, p \equiv \exists x \neg p$, $\neg \exists x, p \equiv \forall x \neg p$:

$$\forall x [\exists y \neg(\neg \text{Animal}(y) \vee \text{Loves}(x, y))] \vee [\exists y \text{ Loves}(y, x)]$$

$$\forall x [\exists y \neg \neg \text{Animal}(y) \wedge \neg \text{Loves}(x, y)] \vee [\exists y \text{ Loves}(y, x)]$$

$$\forall x [\exists y \text{ Animal}(y) \wedge \neg \text{Loves}(x, y)] \vee [\exists y \text{ Loves}(y, x)]$$

Conversion to CNF



3. Standardize variables: each quantifier should use a different one

$$\forall x [\exists y \textit{Animal}(y) \wedge \neg \textit{Loves}(x, y)] \vee [\exists z \textit{Loves}(z, x)]$$

4. Skolemize: a more general form of existential instantiation.
Each existential variable is replaced by a **Skolem function** of the enclosing universally quantified variables:

$$\forall x [\textit{Animal}(F(x)) \wedge \neg \textit{Loves}(x, F(x))] \vee \textit{Loves}(G(x), x)$$

5. Drop universal quantifiers:

$$[\textit{Animal}(F(x)) \wedge \neg \textit{Loves}(x, F(x))] \vee \textit{Loves}(G(x), x)$$

6. Distribute \wedge over \vee :

$$[\textit{Animal}(F(x)) \vee \textit{Loves}(G(x), x)] \wedge [\neg \textit{Loves}(x, F(x)) \vee \textit{Loves}(G(x), x)]$$

Resolution proof: definite clauses

